

# MRS.T RADII SUS

SUSPENDED PROFILES

# DARKON

THE EDGE OF LIGHT

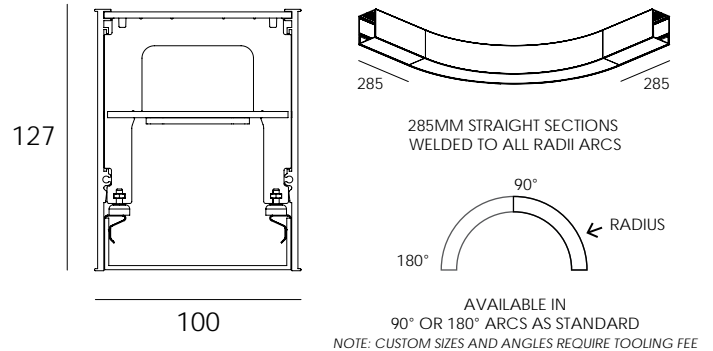
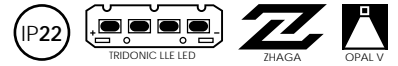
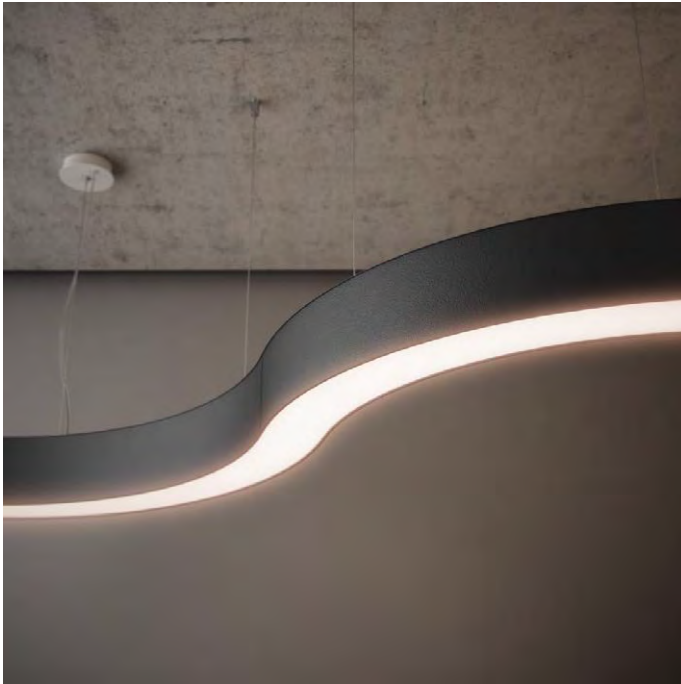

RADIUS IN HORIZONTAL PLANE ONLY (I.E. LENS IS DOWN)  
RADIUS NOT AVAILABLE IN VERTICAL PLANE

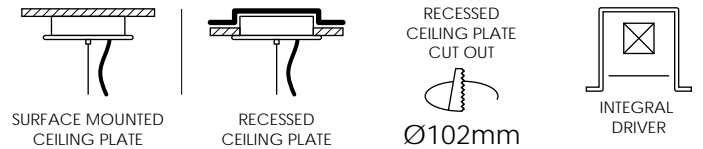

## DESIGN FEATURES

- Dot free homogeneous illumination
- Screwless end caps
- Multiple fixed output options
- Multiple snap fit lens options
- Zhaga compliant LED
- Up to 83 exit lumens per system watt
- 80+ or 90+ colour rendering
- High colour tolerance Macadam 3
- Complies with AS/NZS 60598.2.1
- L80 / F10 = 72,000 hours @ 450mA / 75°C TA

## INSTALLATION FEATURES

- Detailed shop drawings
- Australian made
- Supplied 100% pre-built
- Plug and Play wire looms
- 5 year warranty
- 10 year extended warranty optional
- Project specific labelling referencing type numbers

## LUMEN PERFORMANCE

### TRIDONIC LLE24 FIXED WHITE G5 LED

HE	350mA	16 W p/mtr	1256 lm p/mtr
HE	400mA	18 W p/mtr	1438 lm p/mtr
HE	450mA	21 W p/mtr	1602 lm p/mtr
HE	500mA	23 W p/mtr	1755 lm p/mtr
HO	350mA	30 W p/mtr	2504 lm p/mtr
HO	400mA	35 W p/mtr	2861 lm p/mtr
HO	450mA	39 W p/mtr	3160 lm p/mtr
HO	500mA	43 W p/mtr	3441 lm p/mtr

SYSTEM WATTAGE & EXIT LUMENS  
TESTED WITH OPAL V / WHITE FINISH / 4000K

## CONFIGURATOR

**FINISH:** White / black  
**LENS:** Opal V  
**LED:** HE / HO / Tunable white (2700K-6500K)  
**CURRENT:** 350mA / 400mA / 450mA / 500mA  
**COLOUR TEMP:** 2700K\* / 3000K / 4000K  
**DIMMING:** Non Dim / DALI / DSI / Switch Dim

**NOTES:** R428MM REQUIRES REMOTE DRIVER  
2700K AVAILABLE FOR SIZES R786 AND ABOVE

PROJECT:

TYPE NO.:

QTY:

REV: 18/05/21

DARKON.COM.AU



## STANDARD RADII SIZES

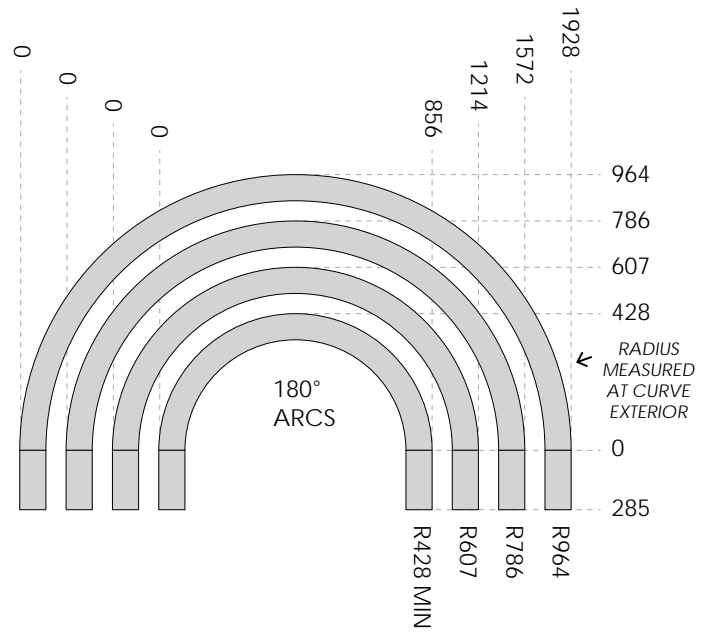
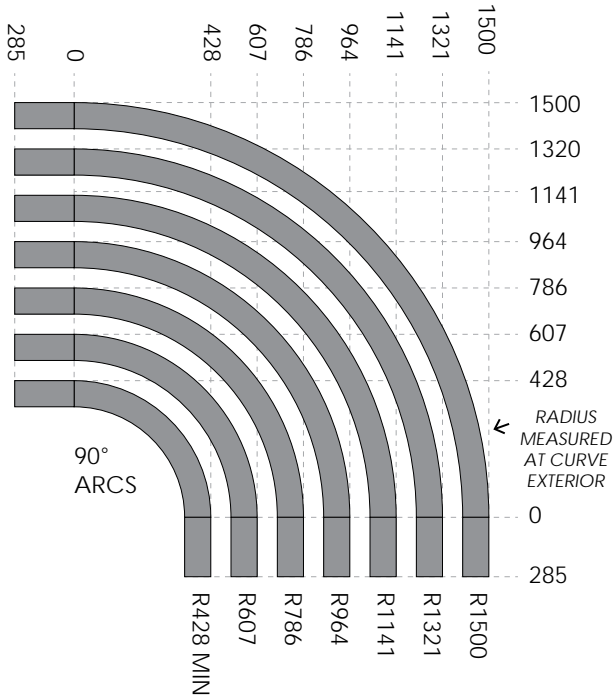

NOTE: CUSTOM SIZES & ANGLES REQUIRE TOOLING FEE

## EXAMPLES OF OPEN SHAPES

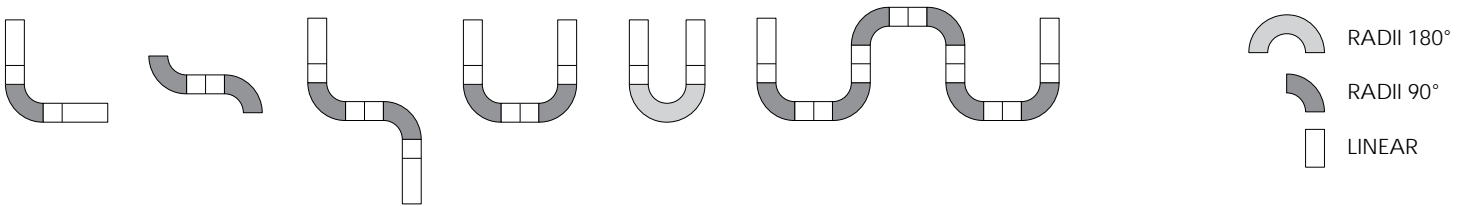

## EXAMPLES OF CLOSED SHAPES

