

# HIP RADII SM

SURFACE MOUNTED PROFILES

# DARKON

THE EDGE OF LIGHT

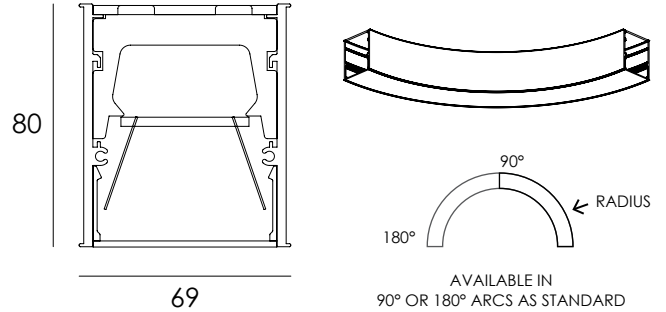
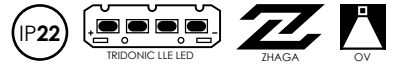

RADIUS IN HORIZONTAL PLANE ONLY (I.E. LENS IS DOWN)  
RADIUS NOT AVAILABLE IN VERTICAL PLANE



## DESIGN FEATURES

- Dot free homogeneous illumination
- Lap join milling - No light bleed
- Screwless end caps
- Multiple fixed output options
- Zhaga compliant LED
- Up to 105 exit lumens per system watt
- 90+ colour rendering, 80+ available upon request
- High colour tolerance Macadam 3
- Complies with AS/NZS 60598.2.1
- L80 / F10 = 72,000 hours @ 450mA / 75°C TA

## INSTALLATION FEATURES

- Detailed shop drawings
- Australian made
- Supplied 100% pre-built
- Plug and Play wire looms
- 5 year warranty
- 10 year extended warranty optional
- Project specific labelling referencing type numbers

## LUMEN PERFORMANCE

### TRIDONIC LLE24 FIXED WHITE G5 LED

HE	200mA	10 W p/mtr	885 lm p/mtr
HE	250mA	12 W p/mtr	1098 lm p/mtr
HE	300mA	14 W p/mtr	1306 lm p/mtr
HE	350mA	16 W p/mtr	1509 lm p/mtr
HE	400mA	18 W p/mtr	1709 lm p/mtr
HE	450mA	20 W p/mtr	1906 lm p/mtr
HE	500mA	23 W p/mtr	2107 lm p/mtr
HO	200mA	17 W p/mtr	1781 lm p/mtr
HO	250mA	21 W p/mtr	2197 lm p/mtr
HO	300mA	25 W p/mtr	2601 lm p/mtr
HO	350mA	29 W p/mtr	2992 lm p/mtr
HO	400mA	33 W p/mtr	3370 lm p/mtr
HO	450mA	37 W p/mtr	3665 lm p/mtr
HO	500mA	42 W p/mtr	4017 lm p/mtr

SYSTEM WATTAGE & EXIT LUMENS  
TESTED WITH OPAL V / WHITE FINISH / 4000K

## CONFIGURATOR

**FINISH:** White / black  
**LENS:** Opal V  
**LED:** HE / HO / Tunable white (2700K-6500K)  
**CURRENT:** 200 / 250 / 300 / 350 / 400 / 450 / 500mA  
**COLOUR TEMP:** 2700K / 3000K / 4000K  
**DIMMING:** Non Dim / DALI / DSI / Switch Dim

**NOTES:** R402MM REQUIRES REMOTE DRIVER

PROJECT:

TYPE NO.:

QTY:

REV: 23/04/24

DARKON.COM.AU

# HIP RADII SM

SURFACE MOUNTED PROFILES

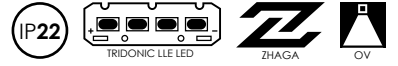

## STANDARD RADII SIZES

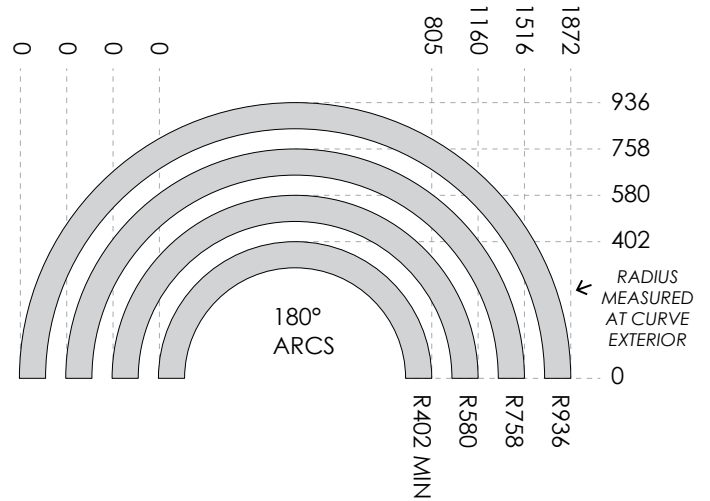
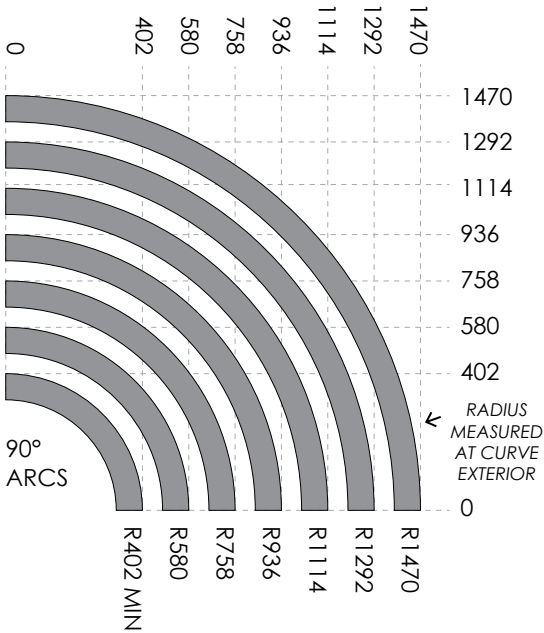

NOTE: CUSTOM SIZES & ANGLES REQUIRE TOOLING FEE

## EXAMPLES OF OPEN SHAPES

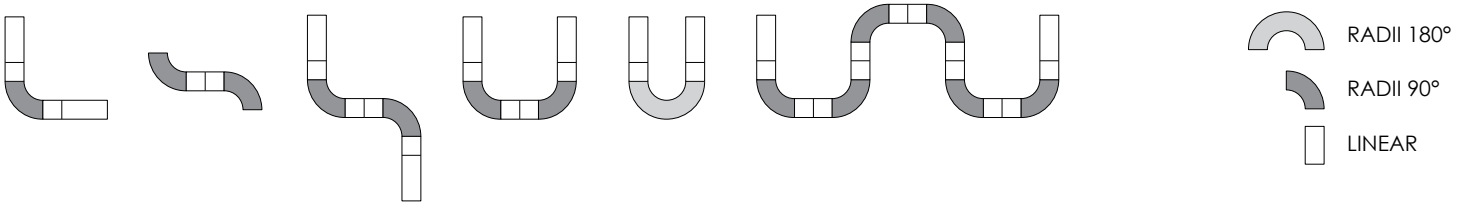

## EXAMPLES OF CLOSED SHAPES

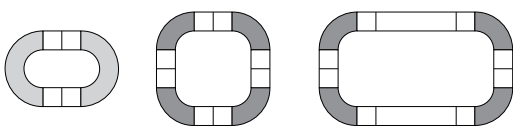

PROJECT:

TYPE NO.:

QTY:

REV: 23/04/24

DARKON.COM.AU