



SR Contour Light CONT V LM10 Monochromatic

FEATURES

- Excellent thermal dissipation encapsulated with high performance grade silicone material that can be used and installed at an extreme harsh environment with temperature up to 65°C
- Designed to be UV and corrosion resistant; meet UL 94 V-0 standard
- One of the smallest bend radius, 10cm, available in market to meet various design requirements
- Beautifully crafted to have a tri-directional illumination structure
- Seamless with no dark spot even at the terminals
- High efficacy luminaire up to 91.6lm/W
- **LED SHIELD™** Technology[†]
- Lifetime: 50,000 hours
- Wide selection of monochromatic colors



SPECIFICATION

Light Output

- Flux per meter
 - Very warm white, 2200K (T), 760lm
 - Warm white, 2700K (T), 900lm
 - Warm white, 3000K (T), 950lm
 - Natural white, 4000K (T), 1000lm
 - Natural white, 5000K (T), 1050lm
 - Cool white, 6500K (T), 1100lm
 - Red, 622.5nm, 270lm
 - Yellow, 590nm, 240lm
 - Green, 525nm, 460lm
 - Blue, 467.5nm, 165lm
- CRI: Ra>80
- Single bin 3-step MacAdam

Electrical

- Supply voltage: 24.0±1.0VDC
- Supply current: 500mA/m typical
- Power range: 12W/m typical
- ESD protection: contact 4kV, air 8kV

Mechanical

- Minimum bending radius: 10cm
- Maximum length for single end power-in: 10m
- IP67
- Cutting pitch: 100mm

Environment

- Ambient temperature: -40°C ... +65°C
- Storage temperature: -40°C ... +85°C

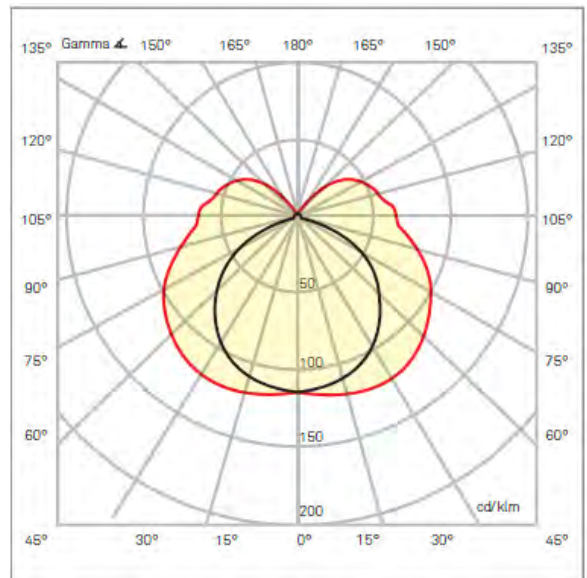

Beam angle: 150°

WARRANTY & CERTIFICATION

- Warranty: 2 years* or L70/B50 at 50khrs
- EN 62031, EN 62471, EN 60598-1, EN 60598-2-1
- EN 55015, EN 61547
- AS/NZS 60598.1, AS/NZS 60598.2.1

* For 5-year warranty, please consult your local sales.

[†] **LED SHIELD™** technology: innovative mechanism protecting segment black out from single LED damage due to inappropriate external force applied during installation and handling.

LuxConex PTE LTD

1 Pemimpin Drive, #09-08 One Pemimpin, Singapore 576151

T: +65-6996 3314 E: contact@luxconex.com W: www.luxconex.com

20200813R2.5



SR Contour Light CONT V LM10 Monochromatic

DIMENSIONS

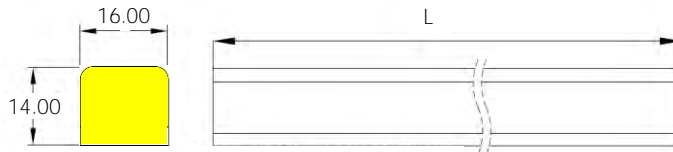

1. Unit: mm
2. L = 10,000mm (10 meters) for 24V product in standard configuration

FEED-IN AND END CAP

Bottom Feeder

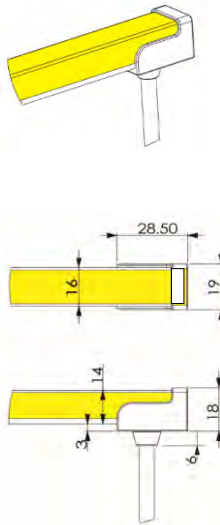

End Feeder

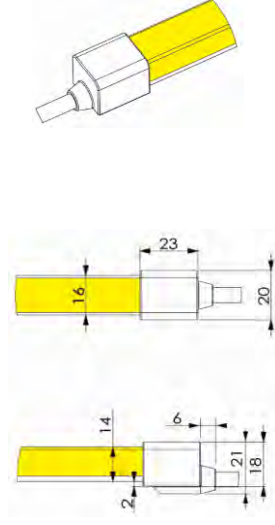

Side Feeder

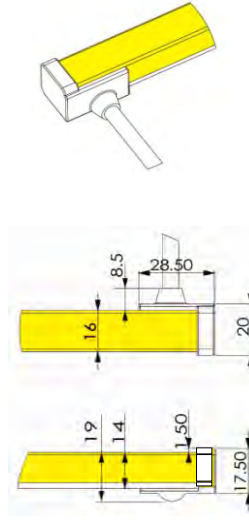

Flush End Cap

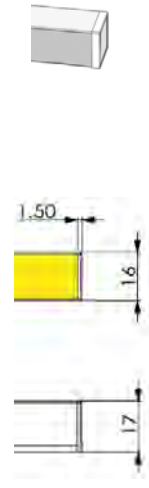

Connector Direction	Product	Feed-in Cable Side	End Cap Side	Total Length
Bottom Feed-in		+2.5mm		L+2.5+2.0 mm
End Feed-in	L mm	+4.0mm	+2.0mm	L+4.0+2.0 mm *
Side Feed-in		+2.5mm		L+2.5+2.0 mm

* Total length does not include the 6mm protrusion of the cable strain relief.

Molded connectors come with 500mm feed-in cable.

LuxConex PTE LTD

1 Pemimpin Drive, #09-08 One Pemimpin, Singapore 576151

T: +65-6996 3314 E: contact@luxconex.com W: www.luxconex.com

MOUNTING ACCESSORIES

Transparent PC Clip
CONT V LM10 TR PC CLIP

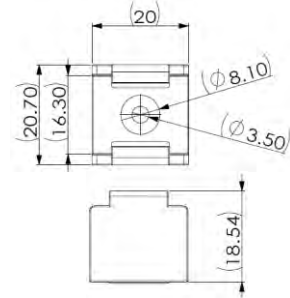

50mm Aluminum Clip
CONT V LM10 AL CLIP 50MM

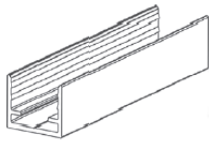

1m Aluminum Profile
CONT V LM10 AL PROFILE 1M

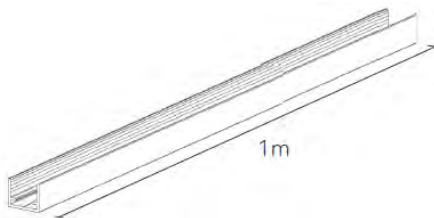

50mm Aluminum Clip with Anti-Skids
CONT V LM10 AL CLIP AS 50MM

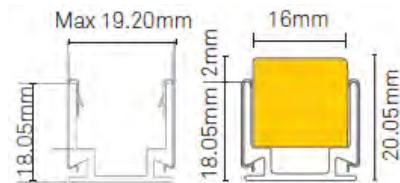
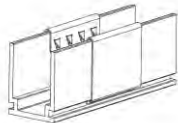

1m Aluminum Profile with Anti-Skids
CONT V LM10 AL PROFILE AS 1M

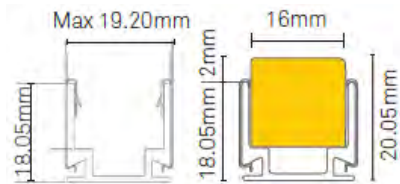
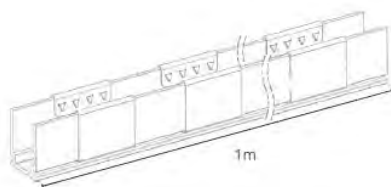



SR Contour Light CONT V LM10 Monochromatic

MOUNTING ACCESSORIES

1m Stainless Steel Curve Profile
CONT V LM10 SS CURVE PROFILE 1M

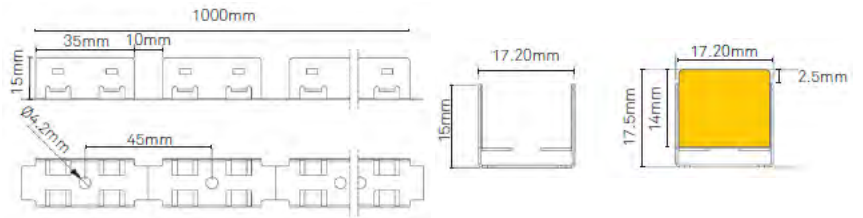

1m Aluminum J Profile
CONT V LM10 AL J-PROFILE 1M

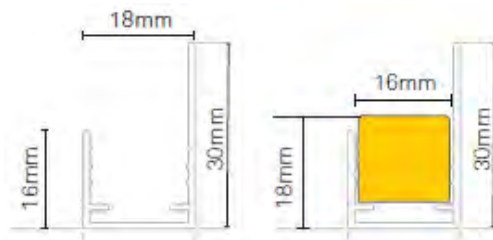
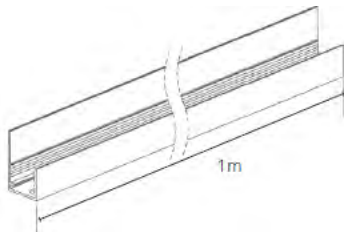

Aluminum L-Bracket
CONT L-BRACKET

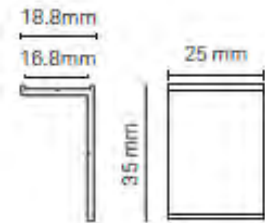
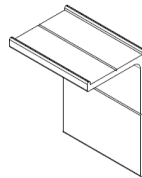

LuxConex PTE LTD

1 Pemimpin Drive, #09-08 One Pemimpin, Singapore 576151

T: +65-6996 3314 E: contact@luxconex.com W: www.luxconex.com



SR Contour Light CONT V LM10 Monochromatic

WIRING

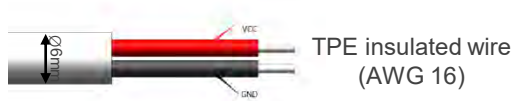

CONNECTION

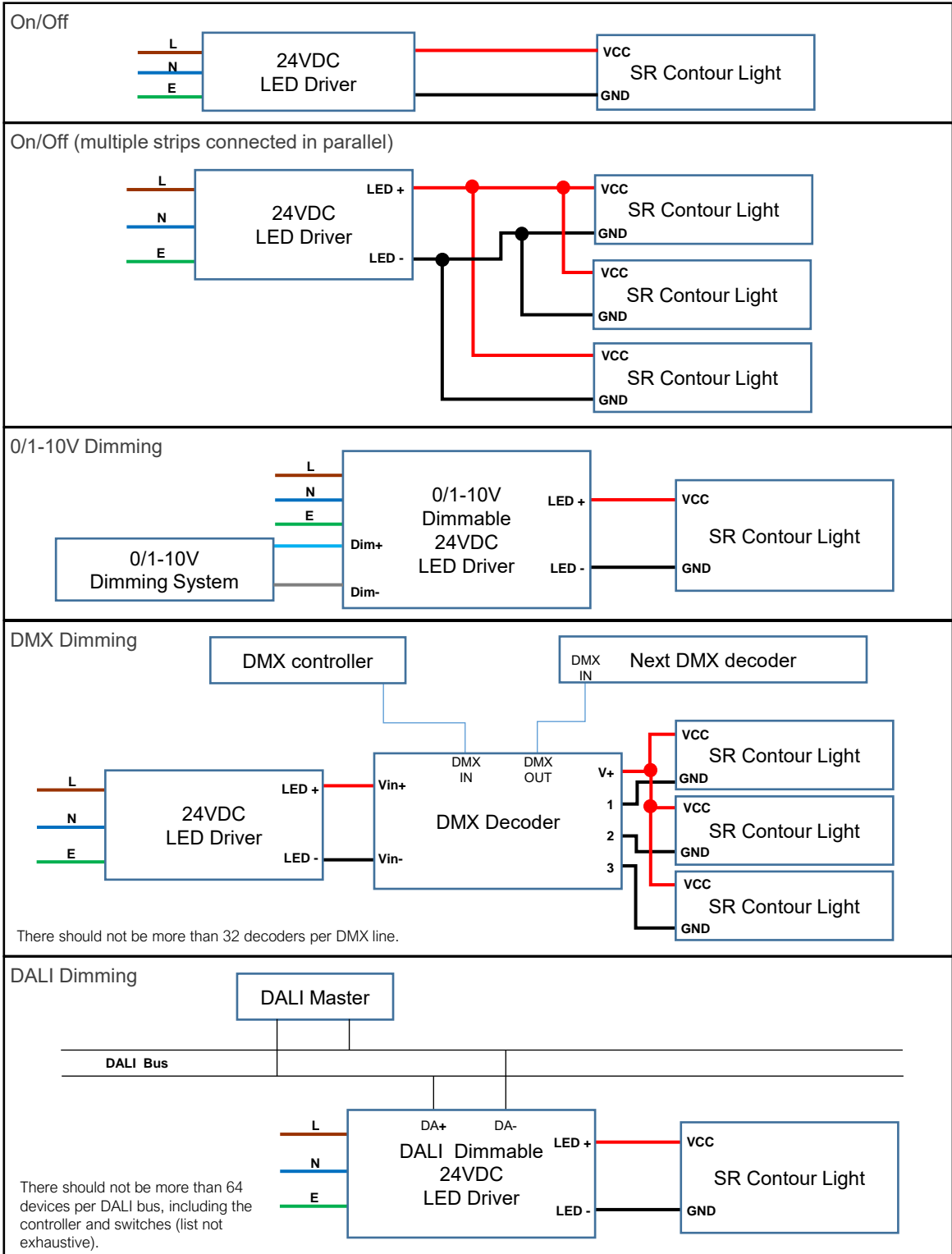

LuxConex PTE LTD

1 Pemimpin Drive, #09-08 One Pemimpin, Singapore 576151

T: +65-6996 3314 E: contact@luxconex.com W: www.luxconex.com



SR Contour Light CONT V LM10 Monochromatic

PACKAGING

- 10-meter Contour Light in one inner box, net weight: 2.5kg
- Shipping unit: 6 inner boxes in one carton
- Shipping box dimension: 575x495x265mm

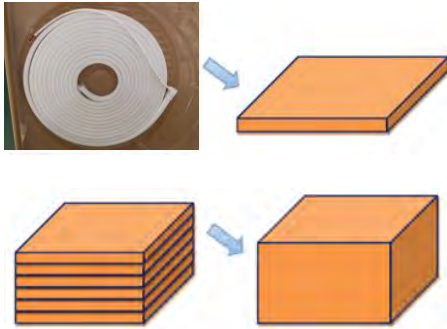

CAUTIONS

- Ensure mains power is switched OFF before carrying out installation, maintenance or replacement operations.
- The Contour Light should be installed by qualified electrical personnel and complying with local codes.
- The power supply should be sized appropriately to adequately power the load with the correct voltage and power ratings; it is generally recommended to have at least 10% power buffer.
- Lightning / Surge protection should be used if not already built into the power supply.
- **DO NOT CUT** the light strip or warranty will be voided.

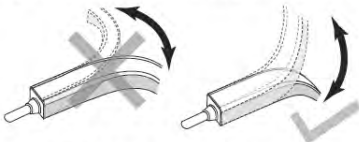

DO NOT BEND the fixture in the wrong direction. If bent horizontally, the fixture can be damaged.

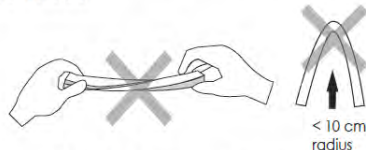

DO NOT TWIST the fixture or **BEND** at less than 10cm radius.

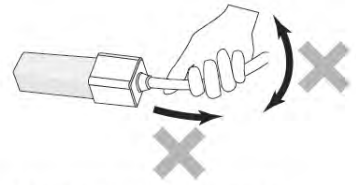

DO NOT STRESS OR PULL HARD on the lead-in cables, nor handle it using the feed-in cables.

CASE TEMPERATURE (tc)

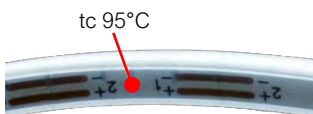

LuxConex PTE LTD

1 Pemimpin Drive, #09-08 One Pemimpin, Singapore 576151

T: +65-6996 3314 E: contact@luxconex.com W: www.luxconex.com



SR Contour Light CONT V LM10 Monochromatic

ORDERING INFORMATION

Product Family	Feed-in Cable Direction for Molded Connector	Color *	Length		
CONT V LM10	MB (bottom feeder)	822	xM (x = length in meters, max 10m)		
		827			
	ME (end feeder)	830			
		840			
	MS (side feeder)	850			
		865			
		RED			
		YELLOW			
				GREEN	
				BLUE	

Example:

CONT V LM10 MS 830 8M denotes CONT V LM10 series, molded connector, side entry cable, flush end cap, CRI Ra80+, CCT 3000K, 8m in length.

* CRI Ra 90+ option available upon special request..

Accessory Part Number	Description
CONT V LM10 TR PC CLIP	transparent PC clip
CONT V LM10 AL CLIP 50MM	aluminum clip, 50mm
CONT V LM10 AL PROFILE 1M	aluminum profile, 1m
CONT V LM10 AL CLIP AS 50MM	aluminum clip with anti-skids (2pcs, 1pc per side), 50mm
CONT V LM10 AL PROFILE AS 1M	aluminum profile with anti-skids (10pcs, 5pcs per side), 1m
CONT V LM10 AL J-PROFILE 1M	aluminum j-profile, 1m
CONT V LM10 SS CURVE PROFILE 1M	stainless steel curve profile, 1m
CONT L-BRACKET	aluminum L-bracket

LED Driver Part Number	Description	Estimated Maximum Strip Length L *
SAV-060N024X02HQA	60W 24V Constant Voltage LED Driver	4m
SAV-096N024X400Q	96W 24V Constant Voltage LED Driver	6.4m
SAV-150N024X625Q	150W 24V Constant Voltage LED Driver	10m

* System design will vary depending on actual project configuration. Please consult your local sales support for detailed strip length calculations, connecting cable type and length calculations.

LuxConex PTE LTD

1 Pemimpin Drive, #09-08 One Pemimpin, Singapore 576151

T: +65-6996 3314 E: contact@luxconex.com W: www.luxconex.com